

Outdoor Rental Hard Connection Led Displays

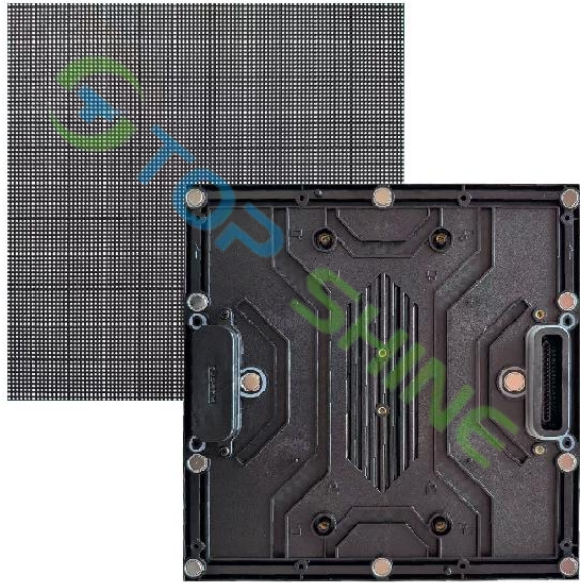

Module Size:250*250mm



Cabinet Size: 500*500mm



Cabinet Size: 1000*500mm

Outdoor Rental Soft Connection Led Displays

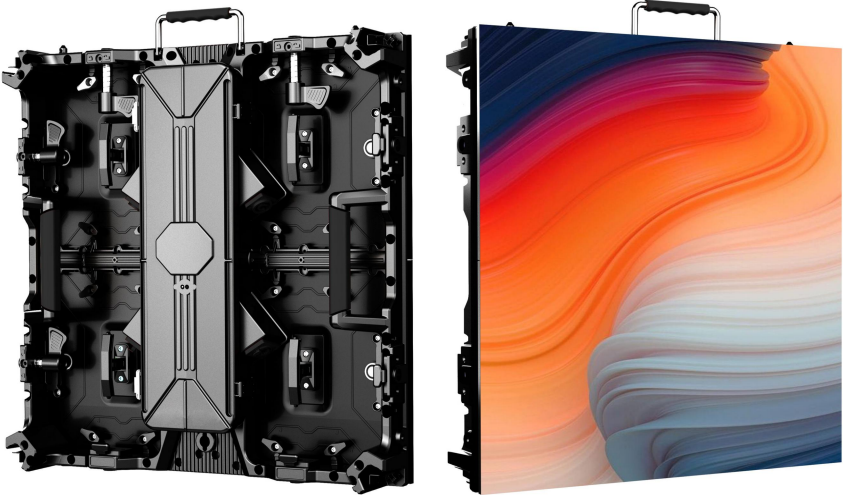
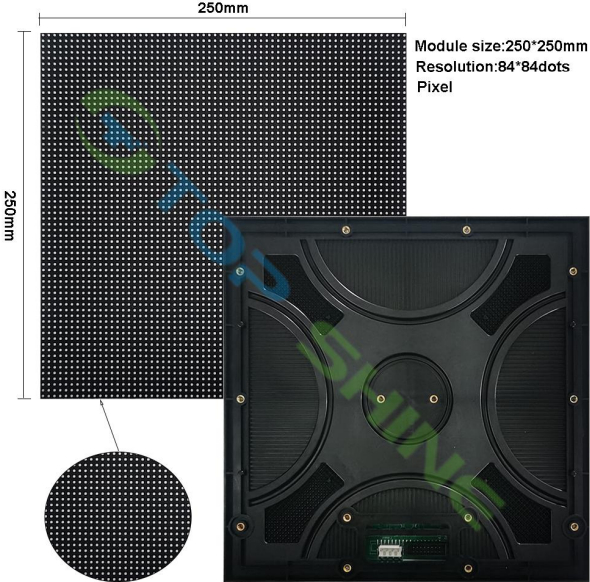

Cabinet Size: 500*500mm

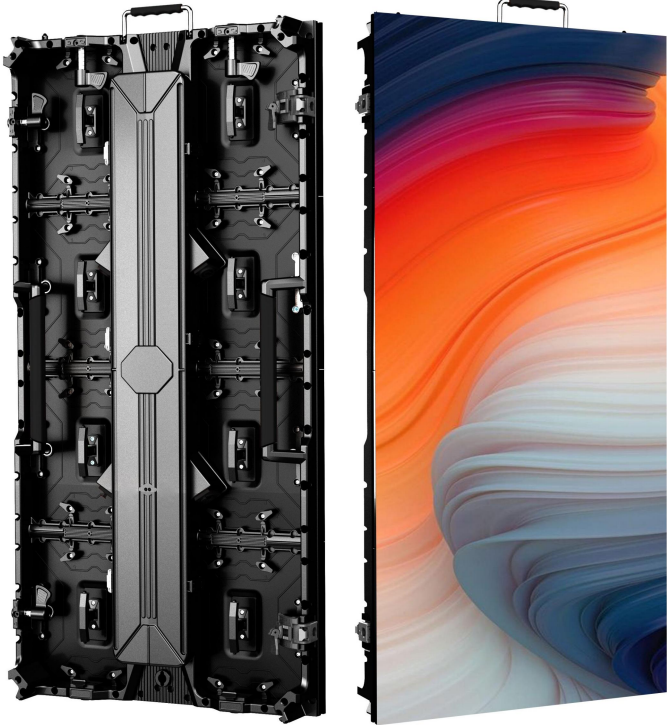

Cabinet Size: 500*500mm

Outdoor Rental Soft Connection Led Displays

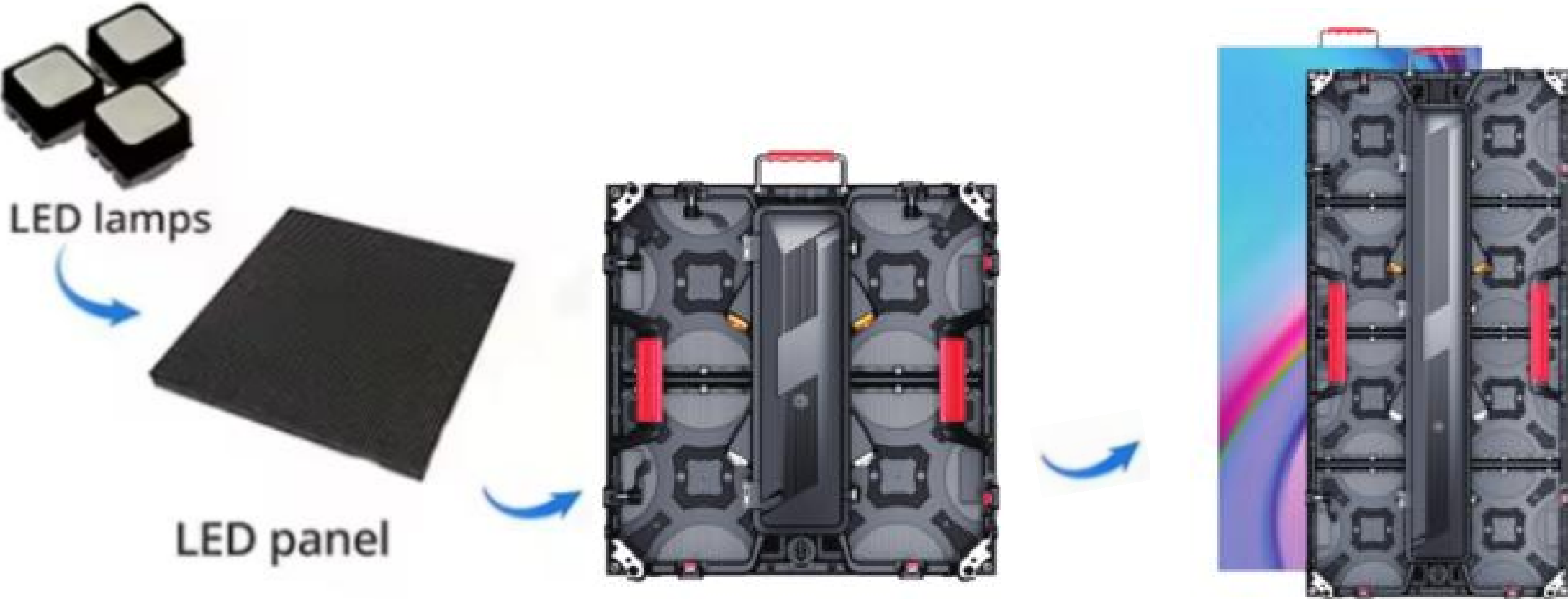

Cabinet Size: 500*500mm

Cabinet Size: 1000*500mm

Outdoor rental LED display

Rental	Outdoor			
	TRO-2.6	TRO-2.9	TRO-3.9	TRO-4.8
Pixel pitch(mm)	2.604	2.976	3.91	4.81
Pixel Density(dot/m2)	147456	112896	65536	43264
LED Type	SMD 1415	SMD1415	SMD 1921	SMD 1921
Module Size(WxHxD)	250*250mm			
Diver Mode(Scan)	1/24scan	1/21scan	1/16scan	1/13Scan
Cabinet material	Die-casting aluminum			
Viewing angle	173deg. (H)173deg. (V)			
Gray scale	4096 gray scale in each red,green,blue color			
Lifespan	100,000hours			
Working voltage	AC220V±15%50/60Hz			
Operation temperature	-30°C~+60°C			
Operation humidity	10%~90%RH			
Brightness(cd/m2)	4000-6000			
Refresh Rate(Hz)	3,840			
Cabinet Size(WxHxD)	500×500×85mm		500×1000×85mm	
IP Level(front/rear)	IP65			

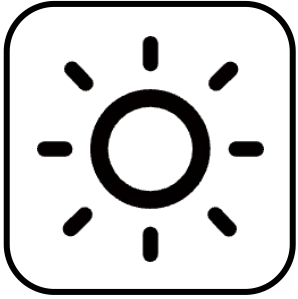

Brightness Reaches
5000-8000 cd/m²



Eye-friendly design for
comfortable viewing
over extended periods.

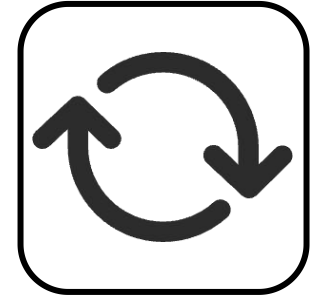

≥3840Hz for flicker-
free, camera-friendly
visuals



IP65 or higher
waterproof and
dustproof ratings

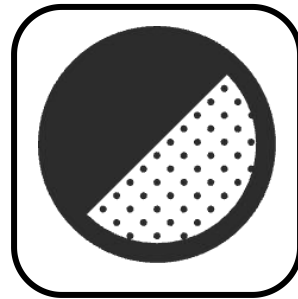

High Grayscale level ≥ 16



Front & rear access
for quick on-site
repairs

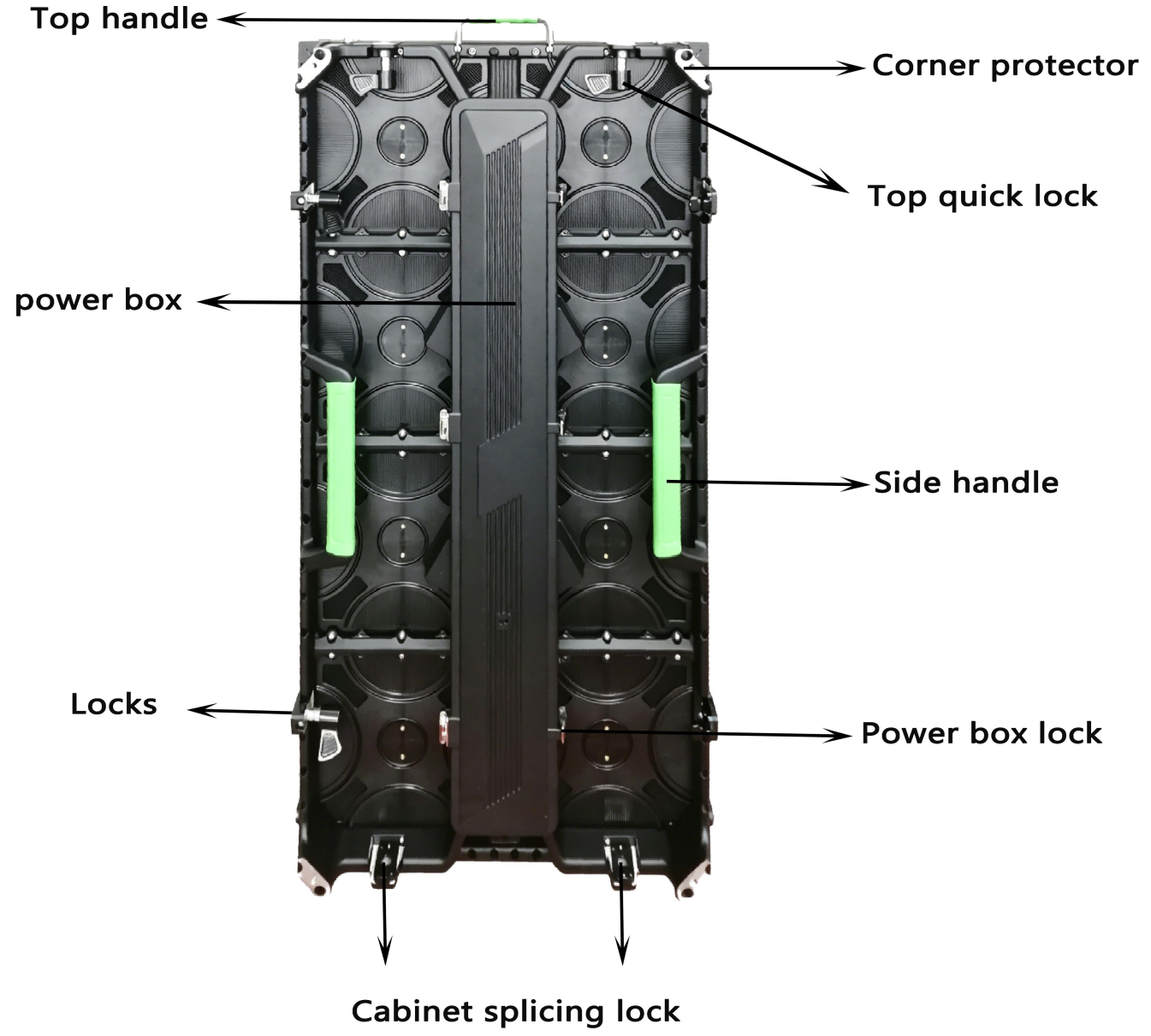

Top handle

Corner protector

Top quick lock

power box

Side handle

Locks

Power box lock

Cabinet splicing lock

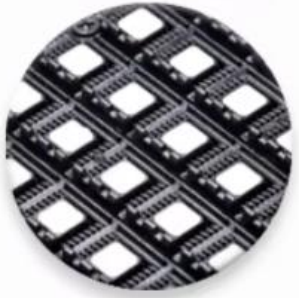

Lamp Beads

1. Low average failure rate
2. Slow color fading
3. Service life: 15 years

Module mask

Indoor & outdoor module with mask to protect the lamp beads for longer life



Chip

3840hz ultra-high refresh rate,
no moiré in photos

Power cable

Ring copper power cable is more resistant and stable



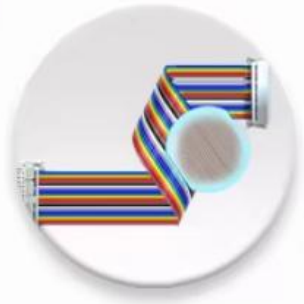

Colored flat cable

All-copper colored flat cable, more stable current, lower failure rate and corrosion resistance

Power supply

Available in all countries, 100V to 240V voltage adjustable range. besides it has obtained CE, FCC, UL certification



The 500 × 500 mm and 500 × 1000 mm cabinets can be easily assembled vertically, meeting diverse assembly requirements.



High protection, anti-collision and anti-knock

The cabinet features a corner guard design, combined with an anti-knock base. It effectively protects the modules and significantly enhances collision and knock resistance.



Supports front and rear dual maintenance

The module supports dual-sided maintenance, making installation and maintenance more convenient.

IP65 Waterproof

Outdoor Led Display Supports Ip65 Dustproof And Waterproof It Can Resist Severe Weather Conditions During Outdoor Activities And Die-Cast Aluminum Is Corrosion Resistant.



Gray Scale & Refresh rate contrast



Ultra wide angle of view

Close viewing distance and wide viewing angle Easy and quick assembling and disassembling



Case

